

# Using HECRAS TO Evaluate Scour At Bridges



County of Orange

Presented to the Flood Division

August 13, 2001

by

Nadeem Majaj

Approximately 575,000 bridges are built over waterways in the US. The most common cause of bridge failure is due to bridge scour of the foundation.

In 1993, the upper Mississippi flooding caused 23 bridge failures.

In 1994, flooding in Georgia (Alberto storm) 500 bridges were scour damaged. 31 experienced 15-20 feet of scour.

# Definition of Scour

Scour is the removal of sediment (soil and rocks) from stream beds and stream banks caused by moving water

## HEC18 - Evaluating Scour At Bridges

HEC18 was originally prepared by the FHWA in 1988. A fourth edition was completed in May 2001 and released to the public in July 2001

## HECRAS - Version 3.0.1

The Hydrologic Engineering Center recently released River Analysis System (HECRAS) version 3.0.1 which includes significant new features, most notably the Unsteady Flow and Bridge Scour options. The bridge scour evaluation follows closely the HEC18 (4th Edition) methodology.

***No reliable equations are available to predict all hydraulic flow conditions that may be reasonably expected to occur. Engineering judgement is required.***

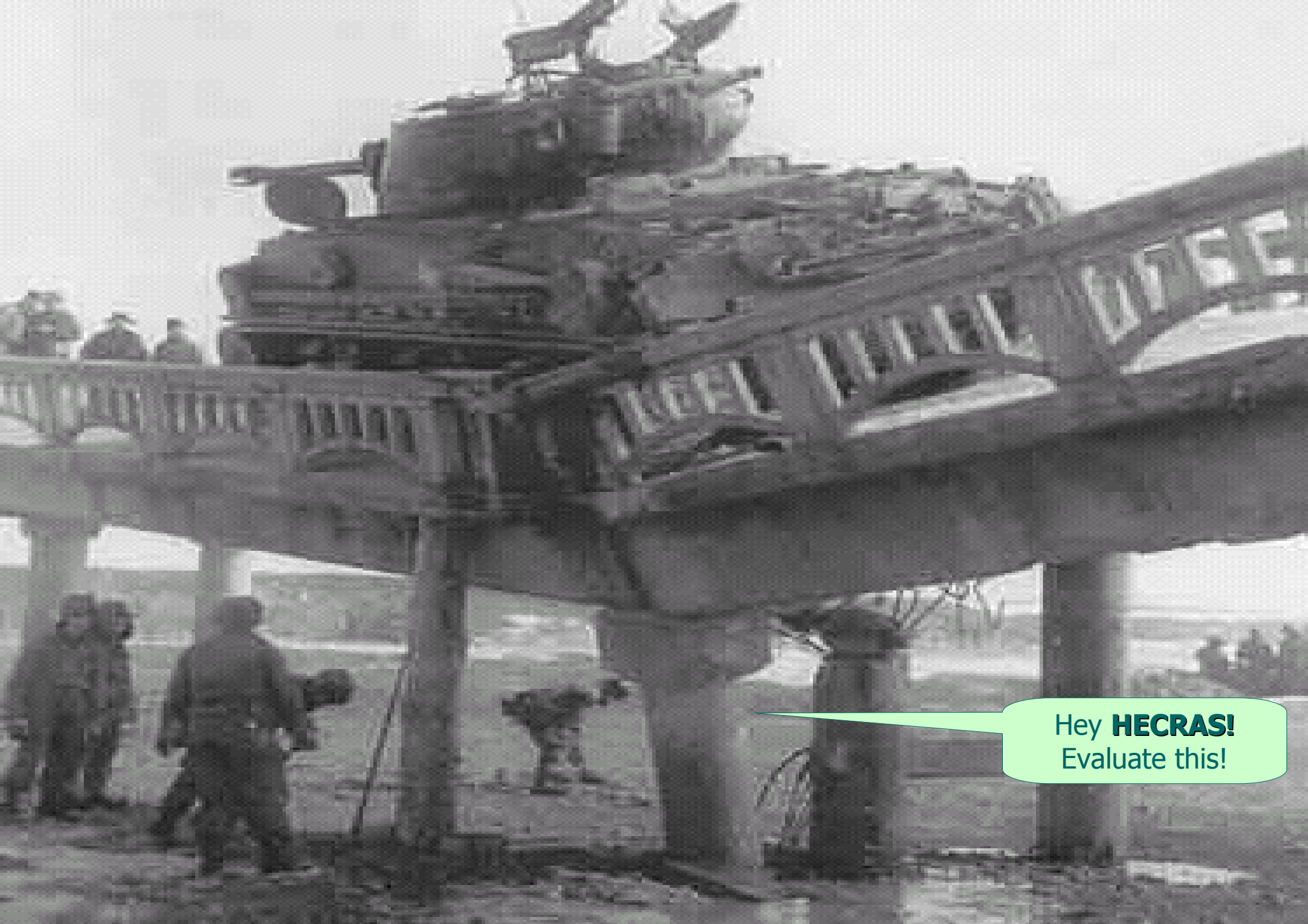

Hey **HECRAS!**  
Evaluate this!

# Rate of Scour

Scour will reach its maximum depth in:

- *sand and gravel bed materials in hours;*
- *cohesive bed materials in days;*
- *glacial tills, sand stones and shales in months;*
- *limestones in years and dense granites in centuries.*



Interstate 90 crossing of Schoharie Creek near Amsterdam, NY on April 5, 1987





Bridge Failure Due to Scour, Glasgow, Missouri

# Components of Scour

I - Long Term Aggradation or Degradation

+

II - Contraction Scour

+

III - Local Scour (Piers and Abutments)

=

Total Scour

## I - Long Term Aggradation or Degradation

II - Contraction Scour

III - Local Scour at Piers and Abutments

# Long-Term Aggradation or Degradation

Long-term aggradation or degradation is due to natural or man-made induced causes which can affect the reach of river on which the bridge is located. The challenge for the engineer is to estimate long-term bed elevation changes that will occur during the life of the structure.

I - Long Term Aggradation or Degradation

II - Contraction Scour

III - Local Scour at Piers and Abutments

# Contraction Scour

Involves removal of material from bed and banks across most of the channel width.

May be “Live-bed Contraction Scour” or “Clear-water Contraction Scour”

I - Long Term Aggradation or Degradation

II - Contraction Scour

III - Local Scour at Piers and Abutments

## Local Scour

**At Piers:** Pier scour occurs due to the acceleration of flow around the pier and the formation of flow vortices. The “horseshoe vortices” remove material from the base of the pier and creates a scour hole.

I - Long Term Aggradation or Degradation

II - Contraction Scour

**III - Local Scour at Piers**

## Scour at a cylindrical pier

Horseshoe and Wake Vortices around a Cylindrical Element

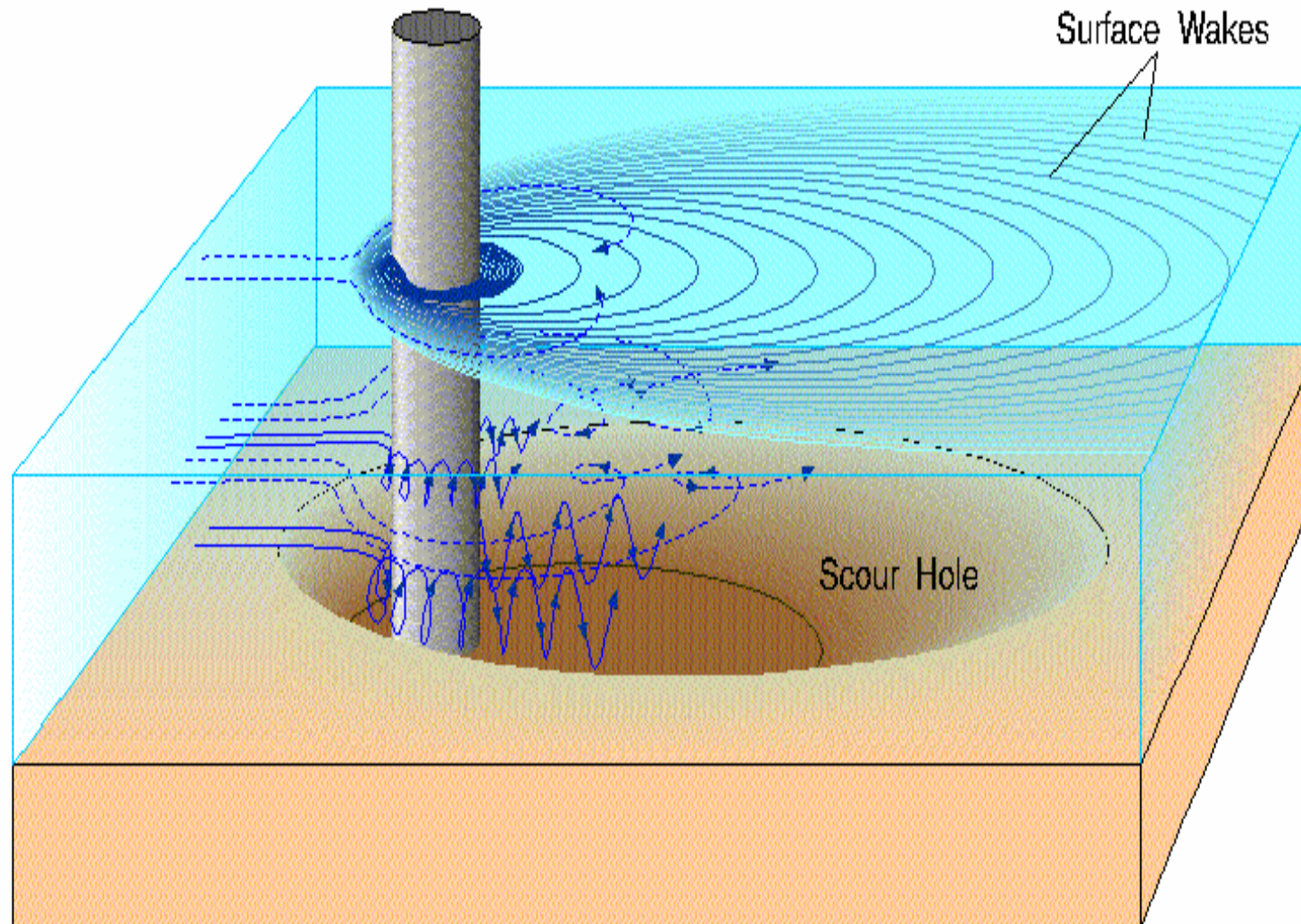

Top View

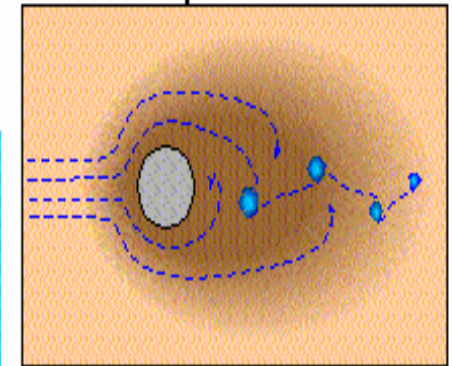

Side View

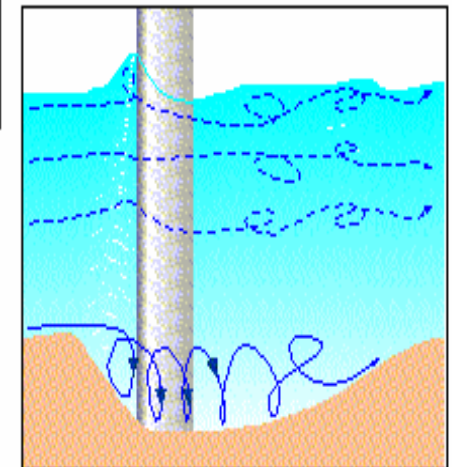

—→ Horseshoe Vortex

- - -→ Wake Vortex

I - Long Term Aggradation or Degradation

II - Contraction Scour

III - Local Scour at Piers and Abutments

## Local Scour

**At Abutments:** The obstruction of the flow forms a horizontal vortex starting at the upstream end of the abutment and running along the toe of the abutment and forms a vertical wake vortex at the downstream end of the abutment

I - Long Term Aggradation or Degradation

II - Contraction Scour

III - Local Scour at Abutments

## Abutment scour

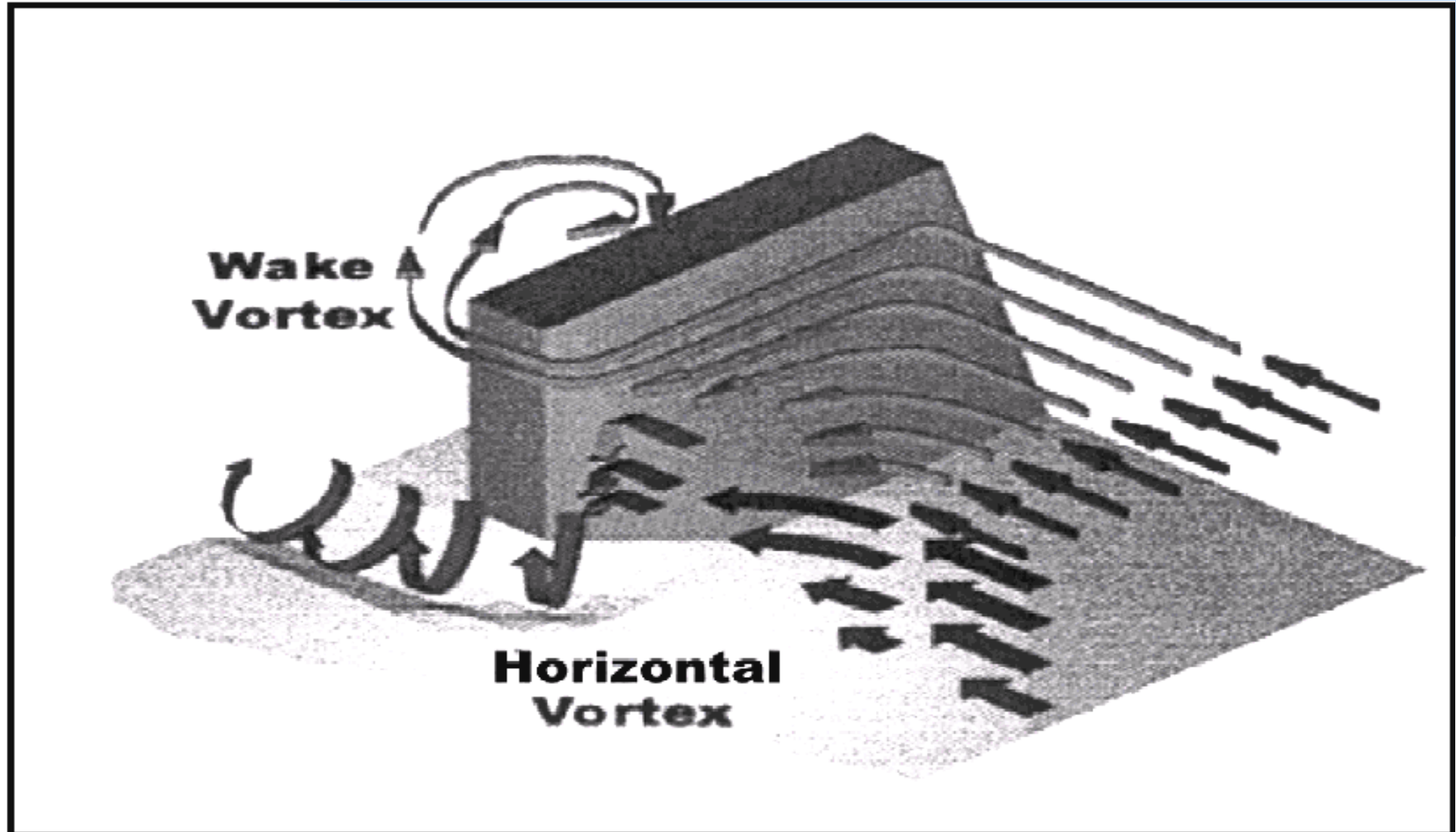





Contraction scour (somewhere) in Missouri during May and June of 1995.



Walnut Street Bridge (Harrisburg, PA) collapse--January 1996







This bridge (location unknown) failed due to scour at the base of the piers caused by a turbulent horseshoe vortex system.



Bridge on the Enoree river in South Carolina which failed due to scour at the base of the piers caused by a turbulent horseshoe vortex system.

Photo: Robert Reynolds, Caltrans

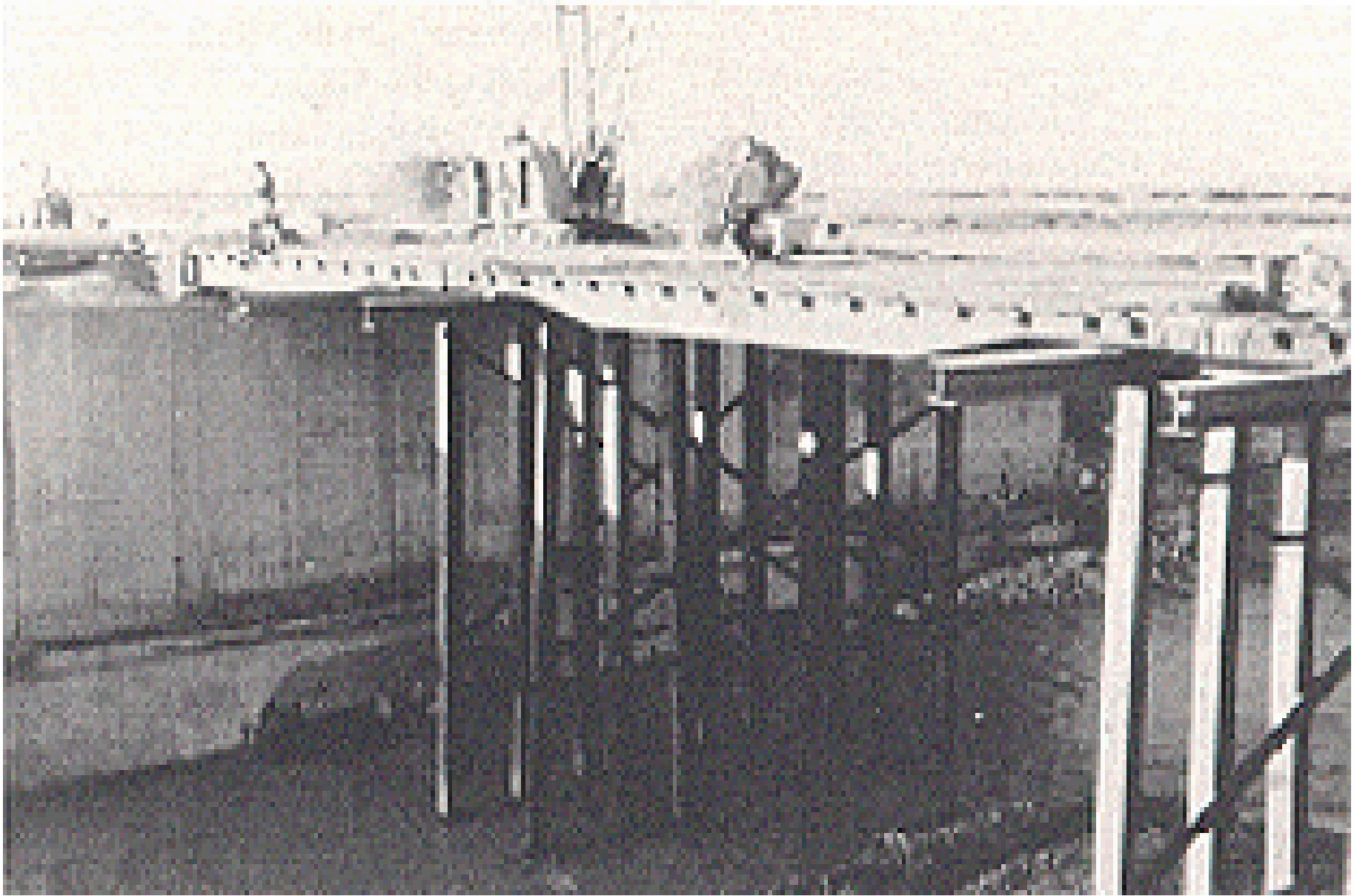

March 10, 1995 - Interstate 5 near Coalinga, over the Arroyo Pasajero

I - Long Term Aggradation or Degradation

II - Contraction Scour

III - Local Scour at Piers and Abutments

# Long-Term Aggradation or Degradation

Procedures for estimating long-term aggradation and degradation at bridges are presented in HEC20 (Stream Stability at Highway Structures) and are not a part of this presentation



I - Long Term Aggradation or Degradation

II - Contraction Scour (Cases)

III - Local Scour at Piers and Abutments

# Contraction Scour Cases

- Case I - Overbank flow on a floodplain being forced back to the main channel by the approaches to the bridge
- Case II - Flow is confined to the main channel (no overbank flow). The normal river channel width becomes narrower due to the bridge itself or the bridge site is located at a narrowing reach of river
- Case III - A relief bridge in the overbank area with little or no bed material transport in the overbank area (clear water scour)
- Case IV - A relief bridge over a secondary stream in the overbank area with bed material transport (similar to case 1)

I - Long Term Aggradation or Degradation

**II - Contraction Scour (Exhibits)**

III - Local Scour at Piers

## Case 1a - Abutments project into channel

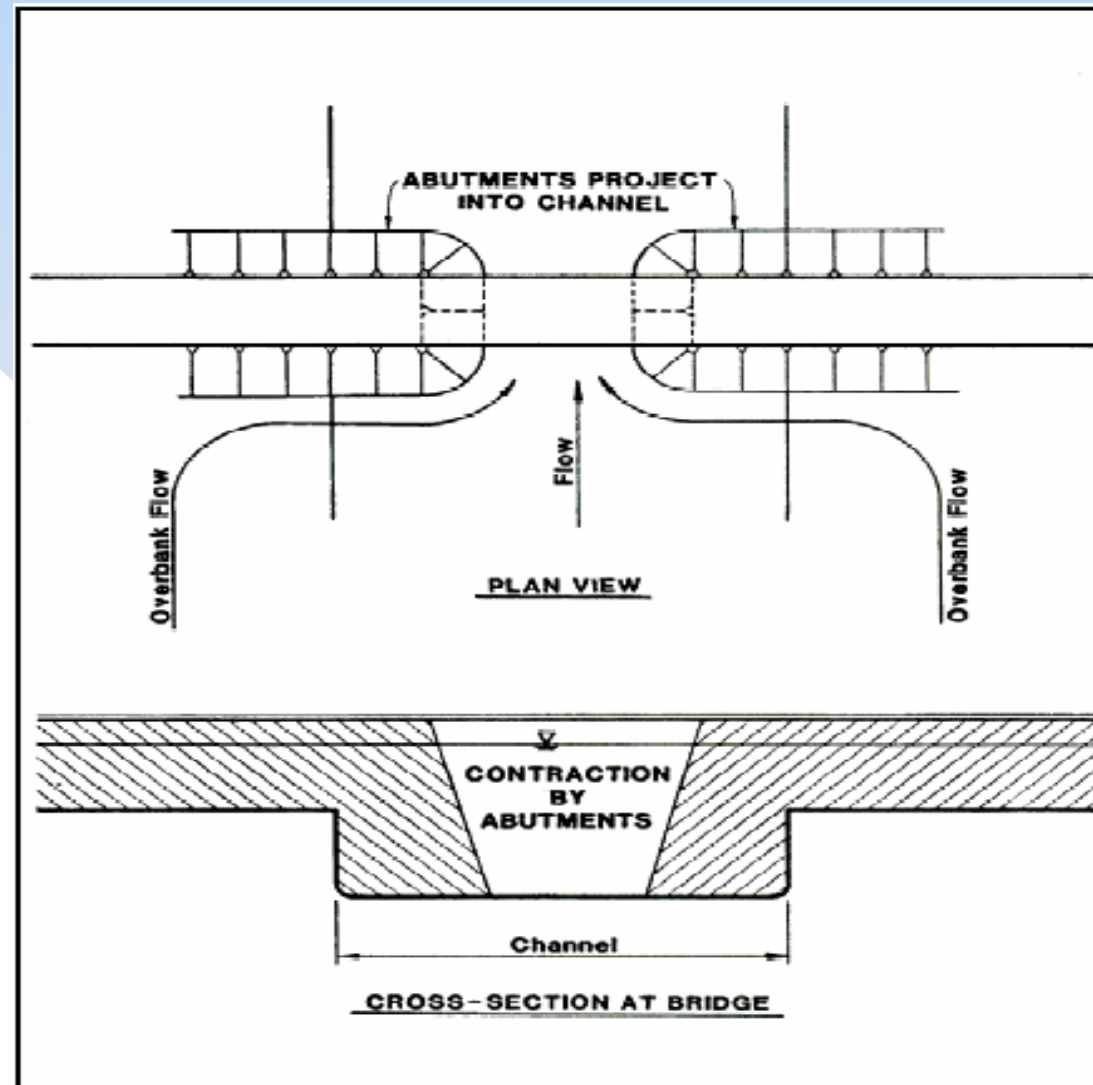

I - Long Term Aggradation or Degradation

**II - Contraction Scour (Exhibits)**

III - Local Scour at Piers

## Case 1b - Abutments at edge of channel

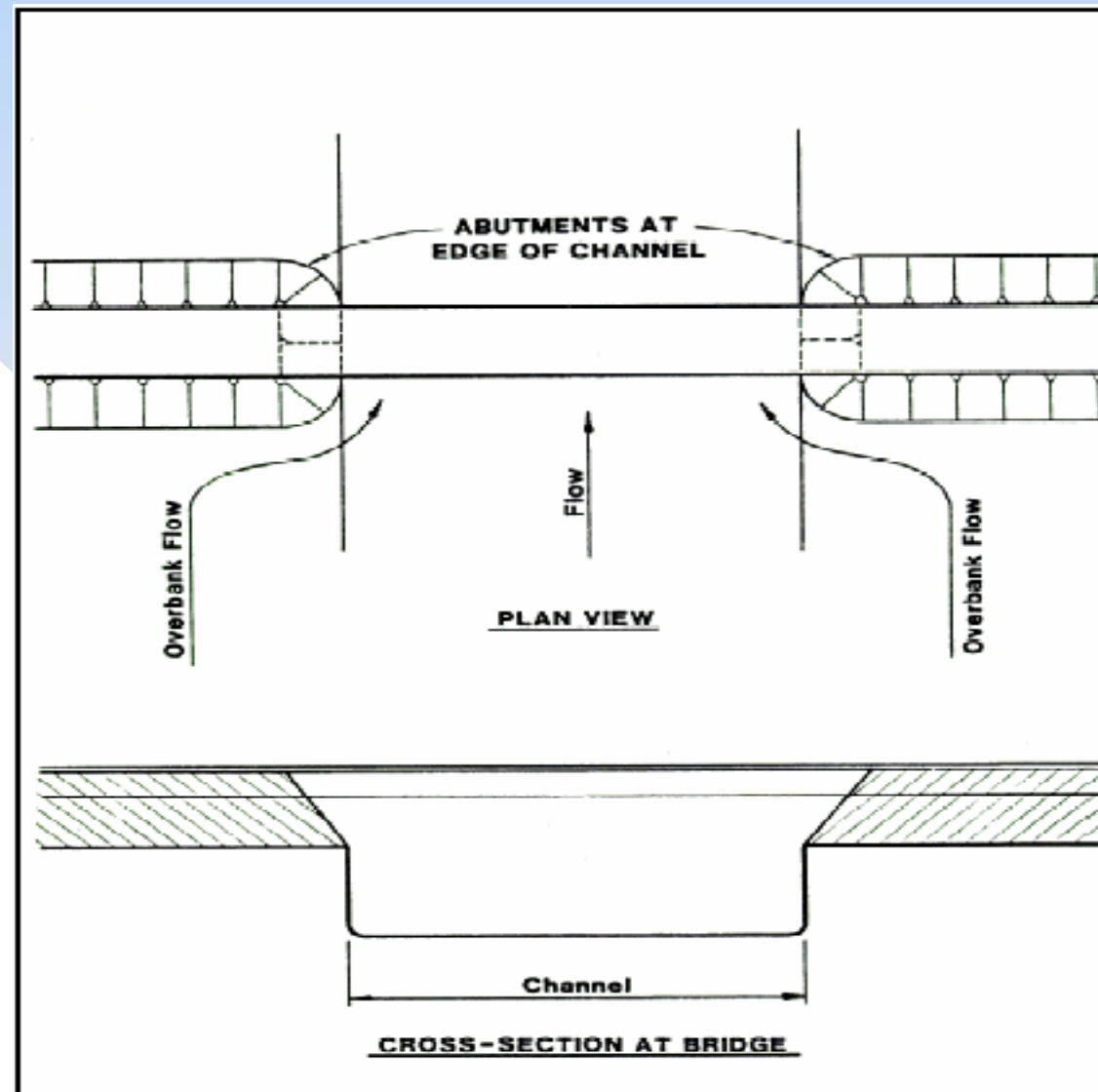

I - Long Term Aggradation or Degradation

**II - Contraction Scour (Exhibits)**

III - Local Scour at Piers

## Case 1c - Abutments set back from channel

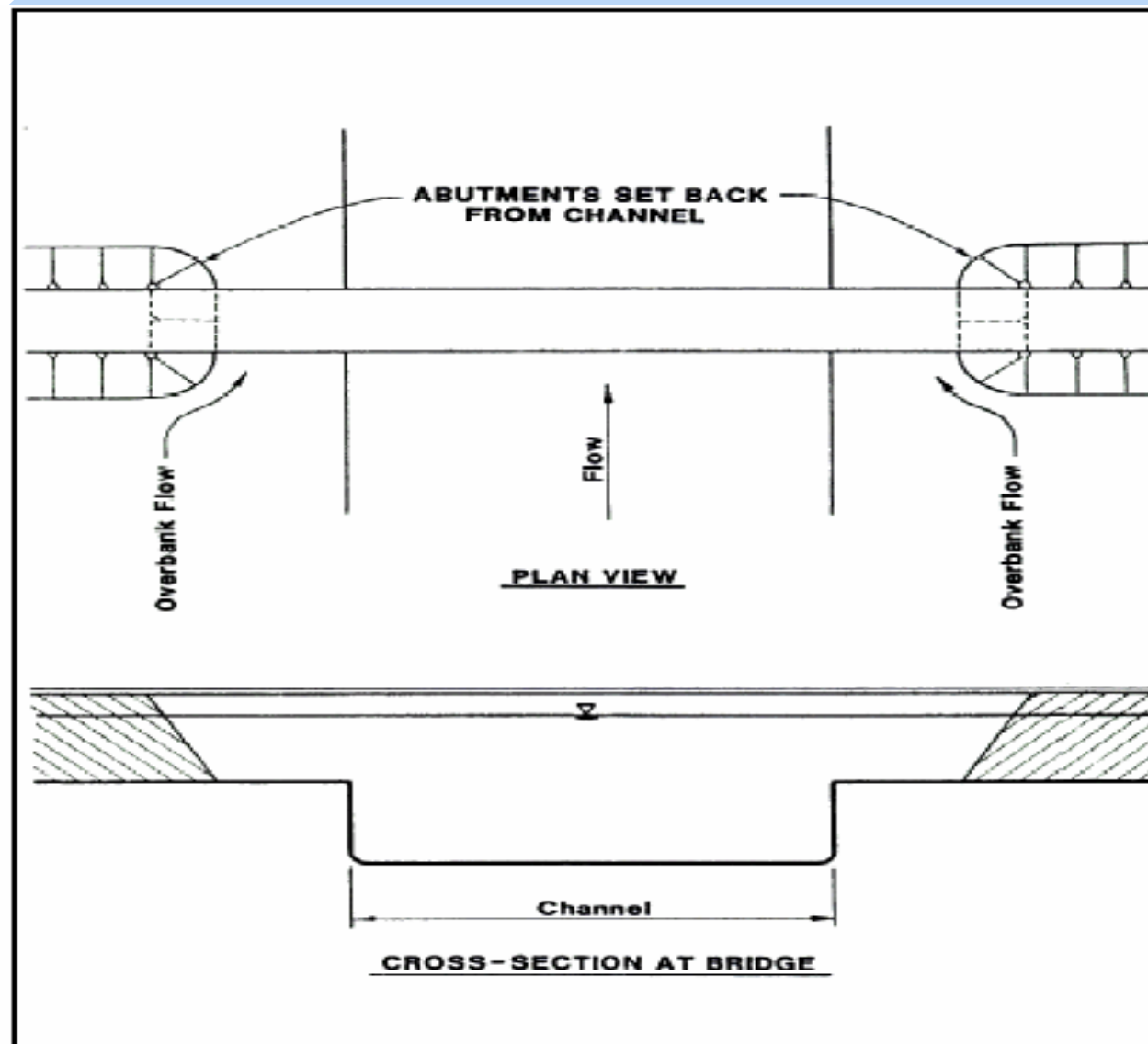

I - Long Term Aggradation or Degradation

**II - Contraction Scour (Exhibits)**

III - Local Scour at Piers

## Case 2a - River narrows

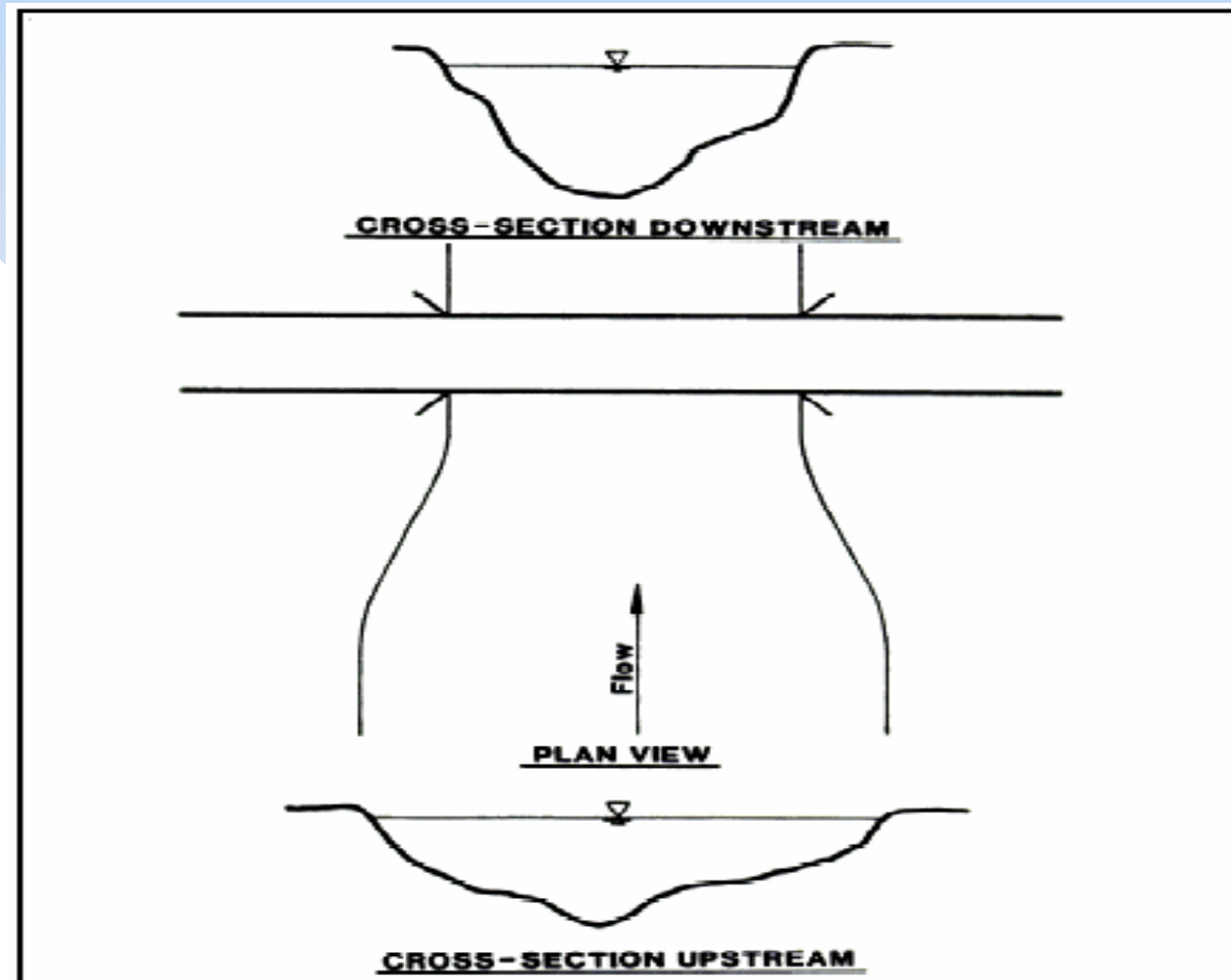

I - Long Term Aggradation or Degradation

**II - Contraction Scour (Exhibits)**

III - Local Scour at Piers

## Case 2b - Bridge abutments and or piers constrict flow

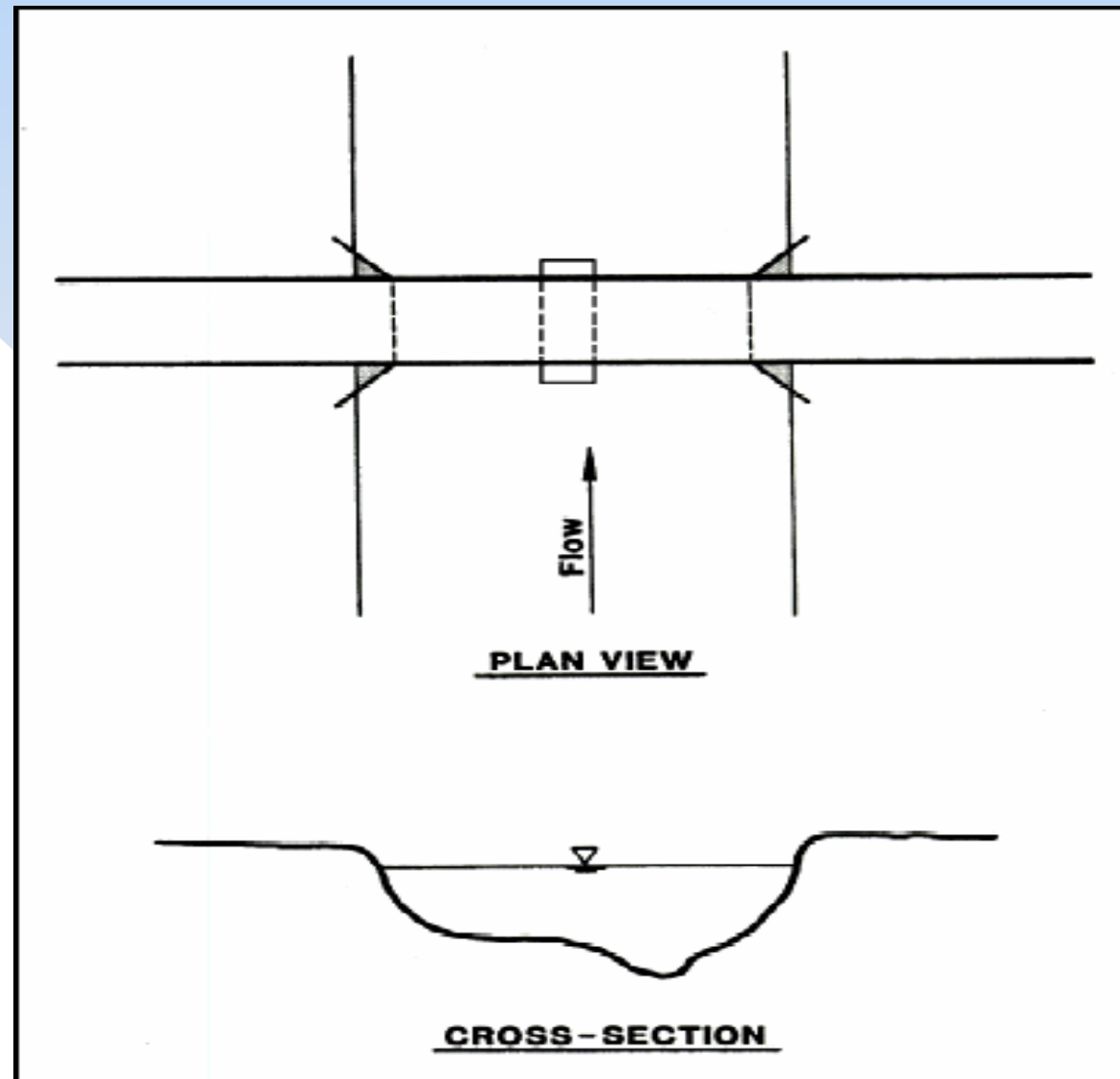

I - Long Term Aggradation or Degradation

II - Contraction Scour (Exhibits)

III - Local Scour at Piers

## Case 3 - Relief bridge over floodplain

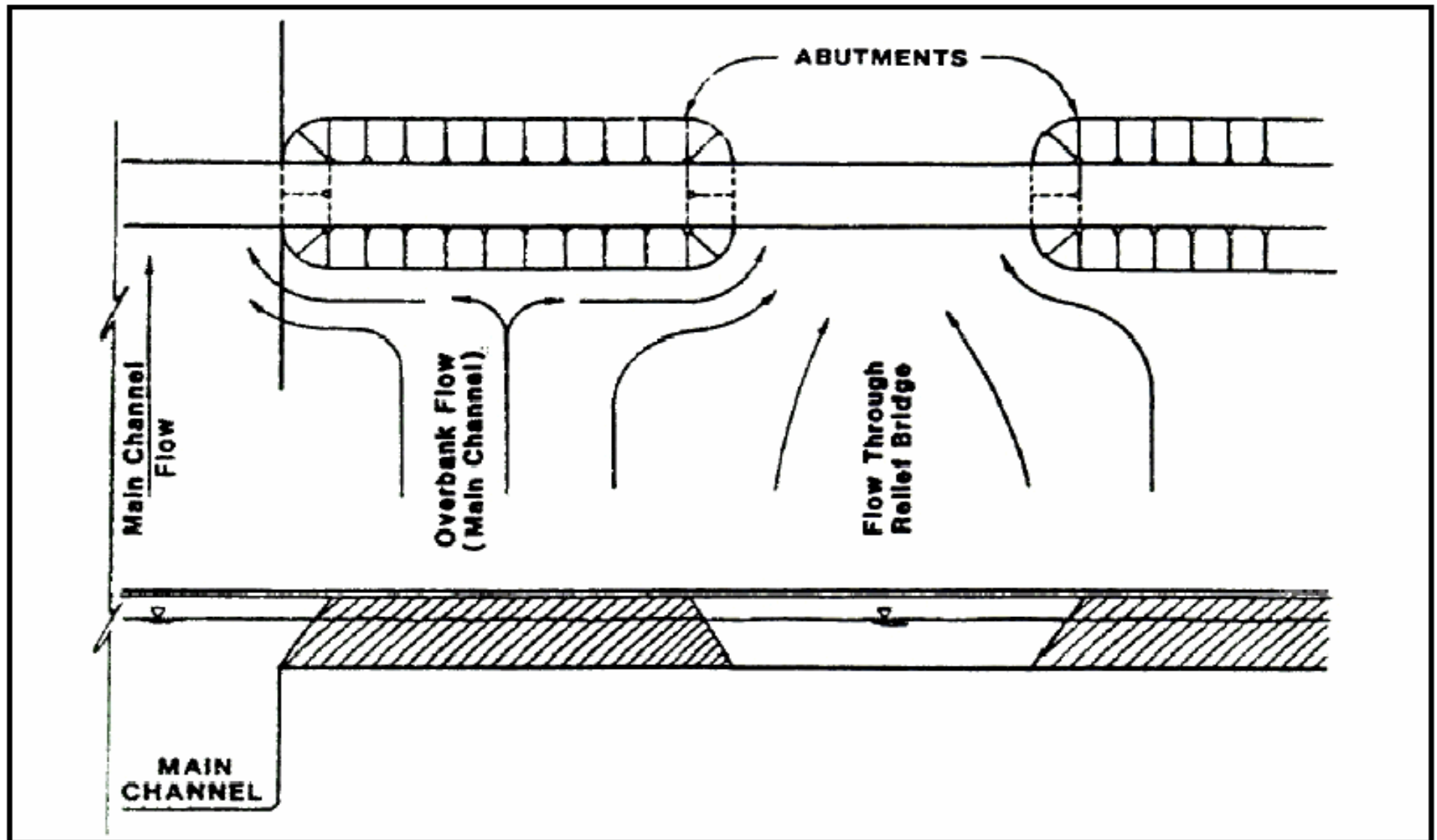

I - Long Term Aggradation or Degradation

**II - Contraction Scour (Exhibits)**

III - Local Scour at Piers

# Case 4 - Relief bridge over secondary stream

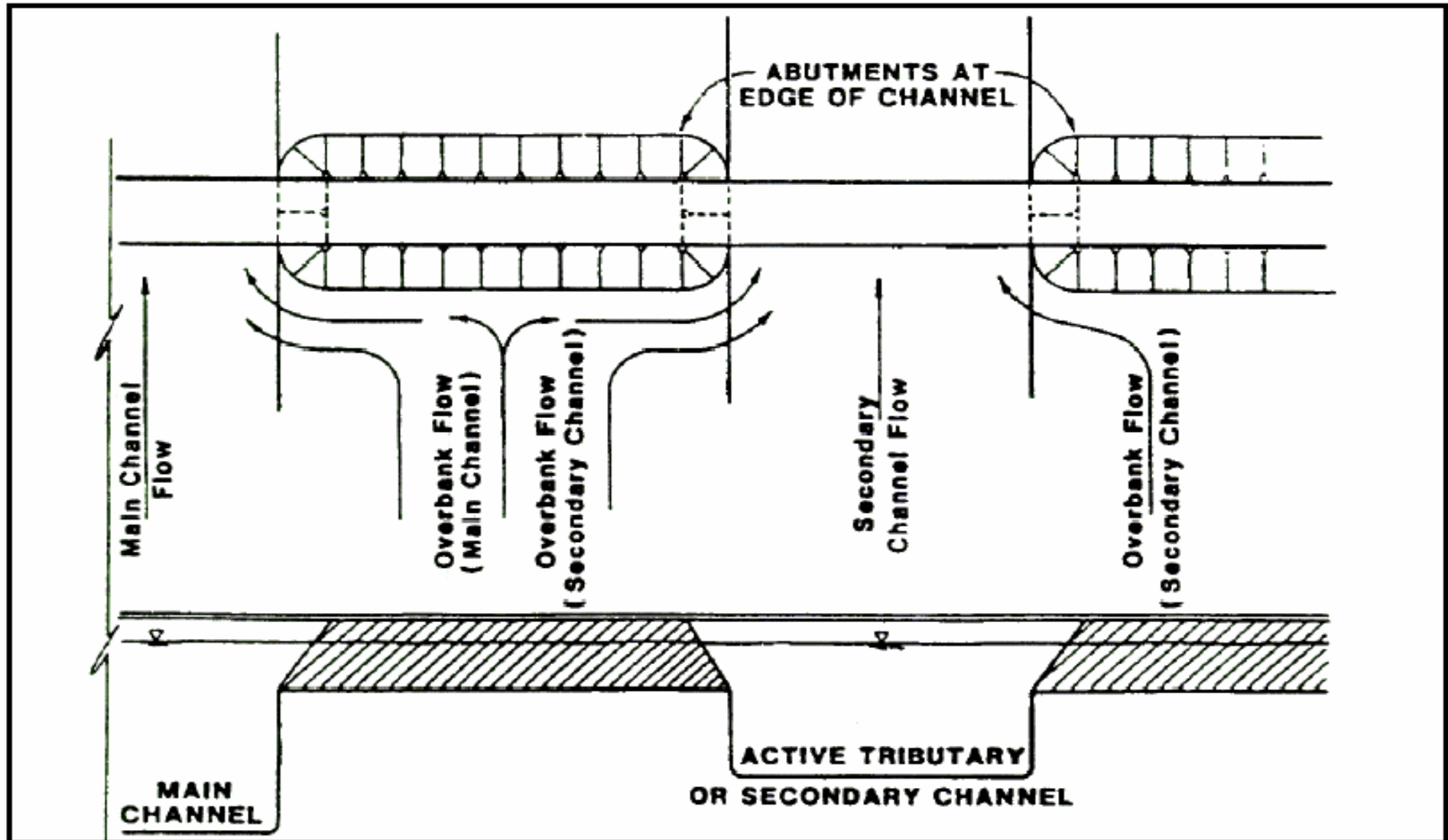



I - Long Term Aggradation or Degradation

II - Contraction Scour (Types)

III - Local Scour at Piers and Abutments

# Contraction Scour Types

## Live-bed Contraction Scour:

This occurs when bed material is already being transported into the contracted bridge section from upstream of the approach section (before the Contraction reach).

I - Long Term Aggradation or Degradation

II - Contraction Scour (Types)

III - Local Scour at Piers and Abutments

# Contraction Scour Types

Clear-water Contraction Scour: This occurs when the bed material sediment transport in the uncontracted approach section is negligible or less than the carrying capacity of the flow.

I - Long Term Aggradation or Degradation

II - Contraction Scour (Type Determination)

III - Local Scour at Piers and Abutments

## Live-bed or Clear-water Determination

Clear-water:  $V_c > \text{mean velocity}$

Live-bed:  $V_c < \text{mean velocity}$

*where  $V_c$  = critical velocity for beginning of motion*

I - Long Term Aggradation or Degradation

**II - Contraction Scour (Determination)**

III - Local Scour at Piers and Abutments

# Live-bed or Clear-water Determination

Clear-water:  $V_c > \text{mean velocity}$

Live-bed:  $V_c < \text{mean velocity}$

$$V_c = 10.95 y_1^{1/6} D_{50}^{1/3} \quad (\text{Laursen, 1963})$$

Where:

$y_1$  = depth of flow in the upstream of bridge

$D_{50}$  = median diameter of bed material

I - Long Term Aggradation or Degradation

**II - Contraction Scour (Live-bed)**

III - Local Scour at Piers and Abutments

## Live-bed Contraction Scour Determination

$$\frac{y_2}{y_1} = \left[ \frac{Q_2}{Q_1} \right]^{6/7} \left[ \frac{W_1}{W_2} \right]^{K_1} \left( \frac{n_2}{n_1} \right)^{K_2} \quad (\text{Laursen, 1960}) \quad \text{And} \quad y_s = y_2 - y_0$$

Where:

$Y_s$  = Average depth of scour

$Y_0$  = Average depth of flow in the contracted section before scour

$Y_1$  = depth of flow in the upstream of bridge

$Y_2$  = depth of flow in the contracted section

$W_1$  = bottom width upstream of bridge

$W_2$  = bottom width in the contracted section

$Q_1$  = flow in the upstream of bridge transporting sediment

$Q_2$  = flow in the contracted section

$n_1$  = Manning's "n" for the upstream of bridge

$n_2$  = Manning's "n" for the contracted section

$K_1$  and  $K_2$  = Exponents depending upon the mode of bed material transport

$V^*/w$	$K_1$	$K_2$	Mode of Bed Material Transport
<0.50	0.59	0.066	Mostly contact bed material
0.50 to 2.0	0.64	0.21	Some suspended bed material discharge
> 2.0	0.69	0.37	Mostly suspended bed material discharge

I - Long Term Aggradation or Degradation

**II - Contraction Scour (Live-bed)**

III - Local Scour at Piers and Abutments

## Live-bed Contraction Scour Determination

$V^*/w$	$K_1$	$K_2$	Mode of Bed Material Transport
<0.50	0.59	0.066	Mostly contact bed material
0.50 to 2.0	0.64	0.21	Some suspended bed material discharge
> 2.0	0.69	0.37	Mostly suspended bed material discharge

$$V_* = \left( \frac{\tau}{\rho} \right)^{\frac{1}{2}} = (gy_1 S_1)^{\frac{1}{2}}$$

Where:

$V_*$  = Shear Velocity in the upstream section

$w$  = Fall velocity of bed material

$T$  = Shear stress on the bed

$\rho$  = Density of water

$g$  = Acceleration of gravity

$S_1$  = Slope of the energy grade line of main channel

I - Long Term Aggradation or Degradation

**II - Contraction Scour (Live-bed)**

III - Local Scour at Piers

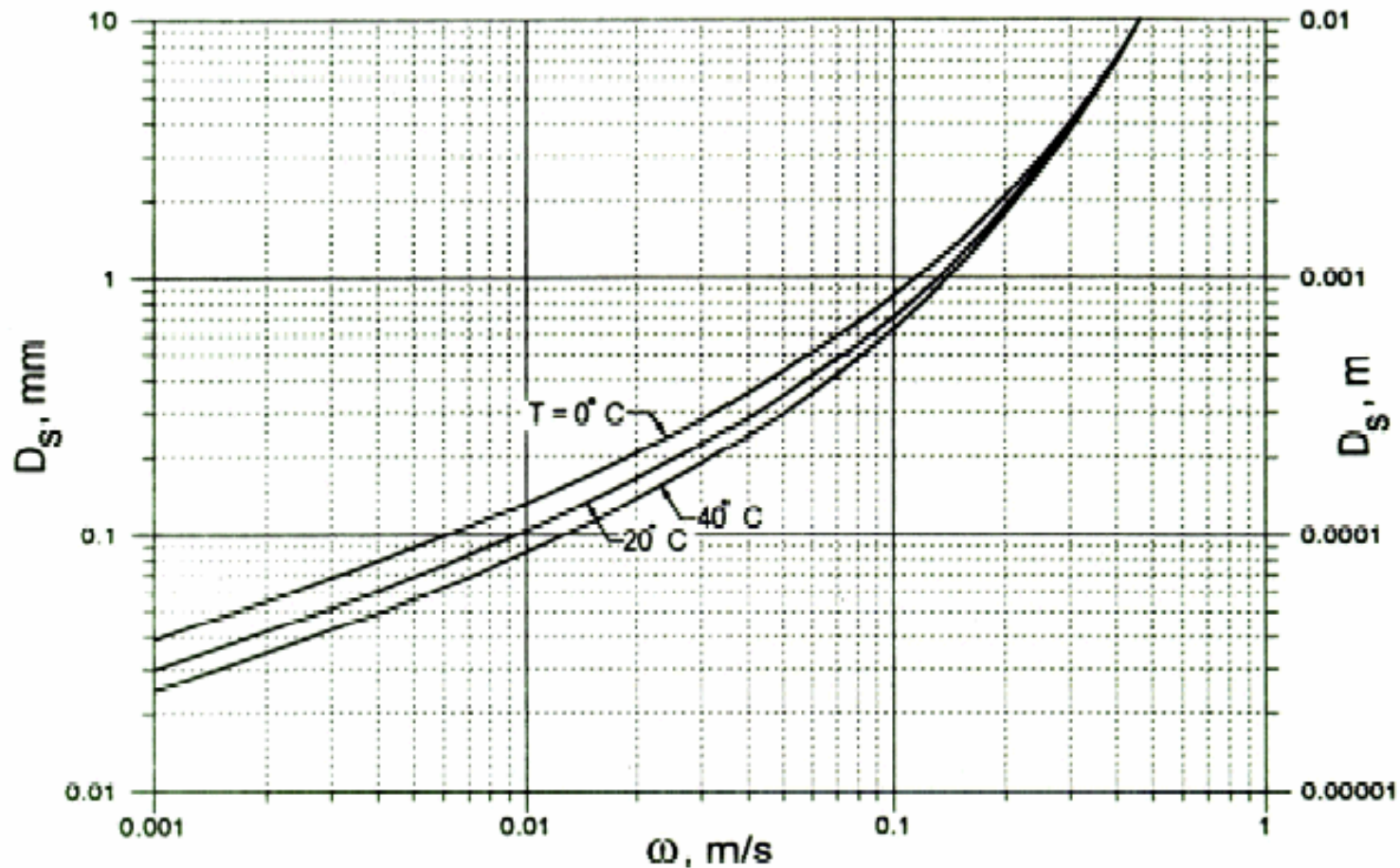

Fall velocity of sand-sized particles with specific gravity of 2.65 in metric

I - Long Term Aggradation or Degradation

**II - Contraction Scour (Live-bed)**

III - Local Scour at Piers and Abutments

## Live-bed Contraction Scour Determination

$$\frac{y_2}{y_1} = \left[ \frac{Q_2}{Q_1} \right]^{6/7} \left[ \frac{W_1}{W_2} \right]^{K_1} \quad \text{Modified (Laursen, 1960)} \quad \text{And} \quad y_s = y_2 - y_0$$

Where:

$Y_s$  = Average depth of scour

$Y_0$  = Average depth of flow in the contracted section before scour

$Y_1$  = depth of flow in the upstream of bridge

$Y_2$  = depth of flow in the contracted section

$W_1$  = bottom width upstream of bridge

$W_2$  = bottom width in the contracted section

$Q_1$  = flow in the upstream of bridge transporting sediment

$Q_2$  = flow in the contracted section

$K_1$  = Exponents depending upon the mode of bed material transport

$V^*/w$	$K_1$	Mode of Bed Material Transport
<0.50	0.59	Mostly contact bed material
0.50 to 2.0	0.64	Some suspended bed material discharge
> 2.0	0.69	Mostly suspended bed material discharge



I - Long Term Aggradation or Degradation

**II - Contraction Scour (Live-bed)**

III - Local Scour at Piers and Abutments

## Live-bed Contraction Scour Determination

$V^*/w$	$K_1$	Mode of Bed Material Transport
<0.50	0.59	Mostly contact bed material
0.50 to 2.0	0.64	Some suspended bed material discharge
> 2.0	0.69	Mostly suspended bed material discharge

$$V_* = \left( \frac{\tau}{\rho} \right)^{\frac{1}{2}} = (gy_1 S_1)^{\frac{1}{2}}$$

Where:

$V_*$  = Shear Velocity in the upstream section

$w$  = Fall velocity of bed material

$T$  = Shear stress on the bed

$\rho$  = Density of water

$g$  = Acceleration of gravity

$S_1$  = Slope of the energy grade line of main channel

I - Long Term Aggradation or Degradation

**II - Contraction Scour (Clear-water)**

III - Local Scour at Piers and Abutments

## Clear-water Contraction Scour Determination

$$\frac{y_s}{y_1} = 0.13 \left[ \frac{Q}{D_m^{\frac{1}{3}} y_1^{\frac{7}{6}} W} \right]^{\frac{6}{7}} - 1 \quad (\text{Laursen, 1963})$$

Where  $D_m$  is the effective mean diameter of the bed material ( $1.25 D_{50}$ )

I - Long Term Aggradation or Degradation

II - Contraction Scour

III - Local Scour (at Piers)

## Local Scour at Piers

Pier scour occurs due to the acceleration of flow around the pier and the formation of flow vortices. The “horseshoe vortices) remove material from the base of the pier and creates a scour hole.



This is erosion caused by the formation of a horseshoe vortex system at the base of a telephone pole. This occurred during the blizzard of '96 in the northeast.



This is erosion due to the formation of a horseshoe vortex around a van.

I - Long Term Aggradation or Degradation

II - Contraction Scour

III - Local Scour (at Piers)

# Pier Scour Factors

- The greater the velocity upstream of the pier the deeper the scour
- An increase in flow depth can have a significant influence on the scour depth. It can be as much as twice.
- As the width of the pier increases, so does the scour depth
- If pier is skewed to the flow, the length can have an influence on the scour depth. When doubling the length, the scour depth increased by 30-60% depending upon angle of attack.
- Size and gradation of the bed material generally will not have an effect on the scour depth. What differs is the time it takes to achieve the maximum scour.
- Shape of the pier plays an important part in the scour depth.
- Formation of debris can increase the width of the pier, change its shape or change its projected length.

I - Long Term Aggradation or Degradation

II - Contraction Scour

**III - Local Scour at Piers**

## **Live-bed and Clear-water Scour Determination by CSU (Richardson 1990 eq.)**

$$\frac{Y_s}{Y_1} = 2.0 K_1 K_2 K_3 K_4 \left( \frac{a}{Y_1} \right)^{0.65} Fr_1^{0.43}$$

where:

$Y_s$  = Scour depth

$Y_1$  = Flow depth directly upstream of the pier

$K_1$  = Correction factor for pier nose shape

$K_2$  = Correction factor for angle of attack of flow

$K_3$  = Correction factor for bed condition

$K_4$  = Correction factor for armoring by bed material size

$a$  = Pier width

$Fr_1$  = Froude number directly upstream of pier

I - Long Term Aggradation or Degradation

II - Contraction Scour

**III - Local Scour at Piers**

## Common Pier Shapes

To be used for determining the  $K_1$  (Pier Nose Shape correction factor) in equation:

$$\frac{Y_s}{Y_1} = 2.0K_1K_2K_3K_4\left(\frac{a}{Y_1}\right)^{0.65} Fr_1^{0.43}$$

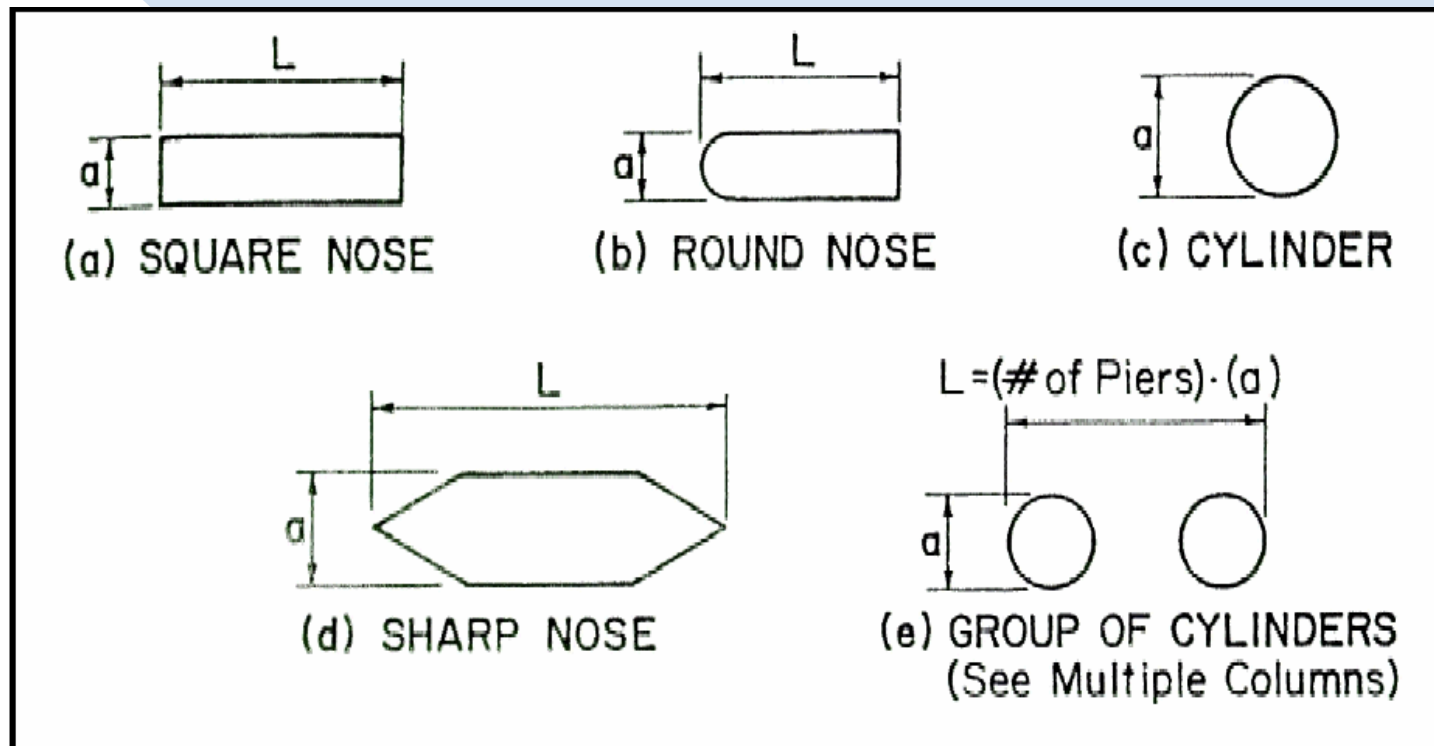



I - Long Term Aggradation or Degradation

II - Contraction Scour

**III - Local Scour at Piers**

$K_1$  is the Pier Nose Shape correction factor in equation:  $\frac{Y_s}{Y_1} = 2.0K_1K_2K_3K_4\left(\frac{a}{Y_1}\right)^{0.65} Fr_1^{0.43}$

Shape of Pier Nose	$K_1$
(a) Square nose	1.1
(b) Round nose	1.0
(c) Circular cylinder	1.0
(d) Group of cylinders	1.0
(e) Sharp nose	0.9

For angle of attack < 5 deg. For greater angles,  
 $K_1=1.0$  and  $K_2$  dominates

I - Long Term Aggradation or Degradation

II - Contraction Scour

**III - Local Scour at Piers**

$$K_2 = (\cos \theta + (L / a) \sin \theta)^{0.65}$$

$K_2$  is the Angle of Attack correction factor in equation:  $\frac{Y_s}{Y_1} = 2.0K_1K_2K_3K_4\left(\frac{a}{Y_1}\right)^{0.65} Fr_1^{0.43}$

Angle	L/a=4	L/a=8	L/a=12
0	1.0	1.0	1.0
15	1.5	2.0	2.5
30	2.0	2.75	3.5
45	2.3	3.3	4.3
90	2.5	3.9	5.0

Angle = skew angle of flow  
L = length of pier, m

Notes:  $K_2$  should only be applied when the entire length is subjected to the attack of flow  
 $K_2$  max = 5.0

I - Long Term Aggradation or Degradation

II - Contraction Scour

**III - Local Scour at Piers**

$K_3$  is the Bed Condition correction factor in equation:

$$\frac{Y_s}{Y_1} = 2.0K_1K_2K_3K_4\left(\frac{a}{Y_1}\right)^{0.65} Fr_1^{0.43}$$

Table 6.3. Increase in Equilibrium Pier Scour Depths,  $K_3$ , for Bed Condition.

Bed Condition	Dune Height m	$K_3$
Clear-Water Scour	N/A	1.1
Plane bed and Antidune flow	N/A	1.1
Small Dunes	$3 > H \geq 0.6$	1.1
Medium Dunes	$9 > H \geq 3$	1.2 to 1.1
Large Dunes	$H \geq 9$	1.3

# I - Long Term Aggradation or Degradation

## II - Contraction Scour

### III - Local Scour at Piers

$K_4$  is the Correction Factor for armoring by bed-material size in equation:

$$K_4 \text{ min} = 0.4$$

If  $D_{50} < 2\text{mm}$  or  $D_{95} < 20\text{mm}$ , then  $K_4 = 1.0$

If  $D_{50} \geq 2\text{mm}$  and  $D_{95} \geq 20\text{mm}$  then

$$K_4 = (V_R)^{0.15}$$

$$\text{where } V_R = \left[ \frac{V_1 - V_{icD_{50}}}{V_{cD_{50}} - V_{icD_{95}}} \right] > 0$$

$$V_{icD_x} = 0.645 \left( \frac{D_x}{a} \right)^{0.053} V_{cD_x}$$

$$V_{cD_x} = K_u Y_1^{\frac{1}{6}} D_x^{\frac{1}{3}}$$

$V_{icD_x}$  = Approach velocity required to initiate scour at the pier for grain size  $D_x$

$V_{cD_x}$  = critical velocity for incipient motion for grain size  $D_x$

$y_1$  = Depth of flow just upstream of the pier, excluding local scour, m (ft)

$V_1$  = Velocity of the approach flow just upstream of the pier, m/s (ft/s)

$D_x$  = Grain size for which x percent of the bed material is finer, m (ft)

$a$  = Pier width (ft)

$K_u$  = 6.19 SI Units

$K_u$  = 11.17 English Units

$$\frac{Y_s}{Y_1} = 2.0 K_1 K_2 K_3 K_4 \left( \frac{a}{Y_1} \right)^{0.65} Fr_1^{0.43}$$

I - Long Term Aggradation or Degradation

II - Contraction Scour

III - Local Scour at Abutments

## Local Scour at Abutments

Local scour occurs at abutments when the abutment and embankment obstruct the flow. The obstruction of the flow forms a horizontal vortex starting at the upstream end of the abutment and running along the toe of the abutment and forms a vertical wake vortex at the downstream end of the abutment

I - Long Term Aggradation or Degradation

II - Contraction Scour

III - Local Scour (at Abutments)

# Abutment failure Causes

- Overtopping of abutments or approach embankments
- Lateral channel migration or stream widening processes
- Contraction scour
- Local scour at one or both abutments

I - Long Term Aggradation or Degradation

II - Contraction Scour

**III - Local Scour at Abutments**

# Abutment Shapes

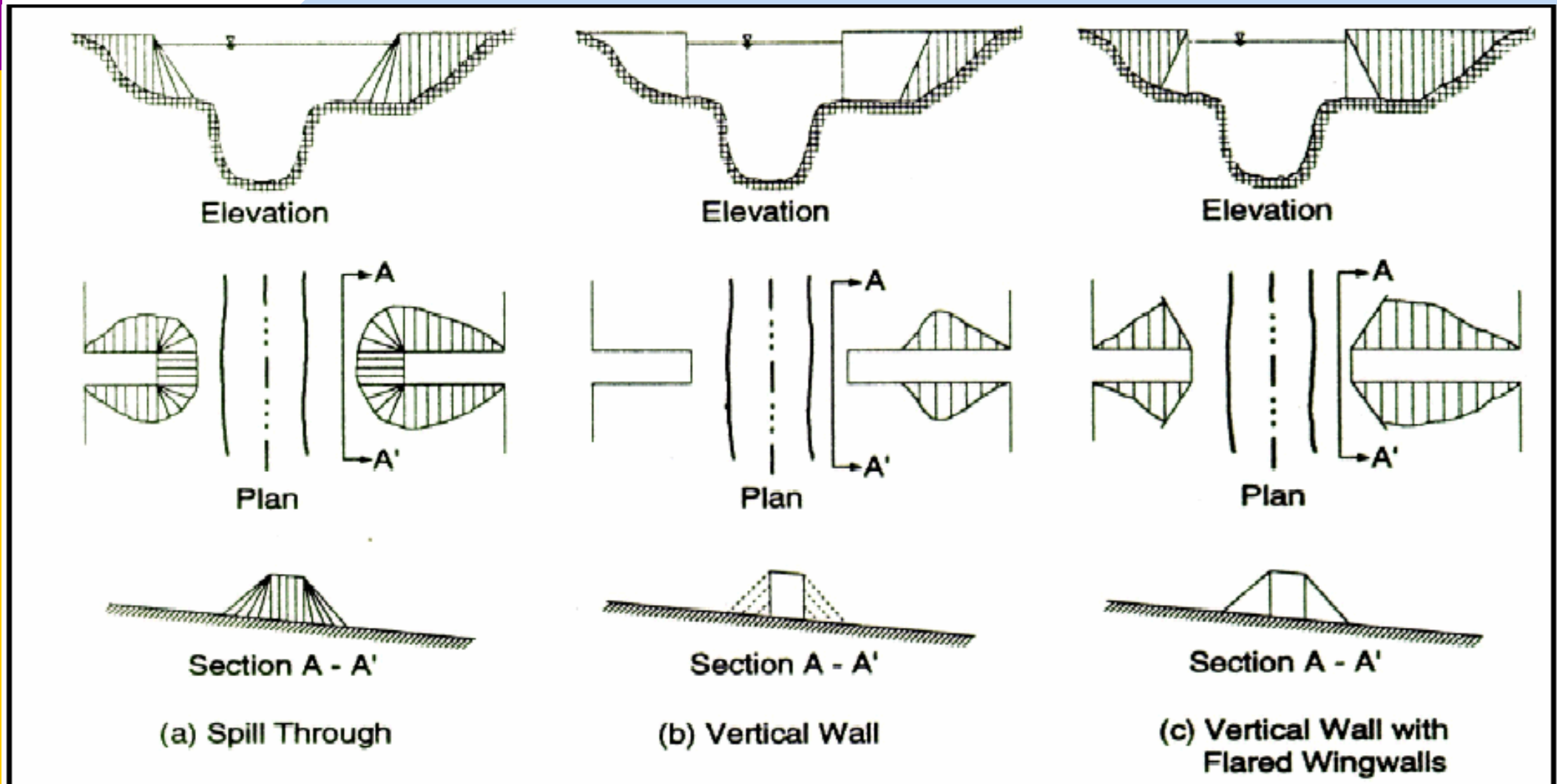

I - Long Term Aggradation or Degradation

II - Contraction Scour

III - Local Scour (at Abutments)

# Abutment Scour Factors

- Velocity of the flow just upstream of the abutment
- Depth of flow
- Length of the abutment if skewed to the flow.



I - Long Term Aggradation or Degradation

II - Contraction Scour (Clear-water)

**III - Local Scour at Abutments**

# **Live-bed and Clear-water Scour Determination**

## **I - Froelich's Live-bed Abutment Scour Equation**

(when the ratio of the length of the abutment (normal to flow) to flow depth  $\leq 25$ )

## **II - Hire Live-bed Abutment Scour Equation**

(when the ratio of the length of the abutment (normal to flow) to flow depth  $> 25$ )

I - Long Term Aggradation or Degradation

II - Contraction Scour (Clear-water)

**III - Local Scour at Abutments**

## I - Froelich's (1989) Live-bed Abutment Scour Equation

(ratio of the length of the abutment (normal to flow) to flow depth  $\leq 25$ )

$$\frac{Y_s}{Y_a} = 2.27 K_1 K_2 (L')^{0.43} y_a^{0.57} Fr_1^{0.61} + 1$$

Where

$K_1$  = Coefficient for abutment shape

$K_2$  = Coefficient for angle of embankment to flow

$$K_2 = (\theta / 90)^{0.13}$$

$\theta < 90$  if embankment points downstream

$\theta > 90$  if embankment points upstream

$L'$  = Length of active flow obstructed by the embankment

$A_e$  = Flow area of the approach cross section obstructed by the embankment

$Fr$  = Froude Number of approach flow upstream of the abutment

$$= V_e / (g y_a)^{1/2}$$

$$V_e = Q_e / A_e$$

$Q_e$  = Flow obstructed by the abutment and approach embankment

$Y_a$  = Average depth of flow on the floodplain ( $A_e / L$ )

$L$  = Length of embankment projected normal to the flow

$Y_s$  = Scour depth

I - Long Term Aggradation or Degradation

II - Contraction Scour (Clear-water)

**III - Local Scour at Abutments - Froelich**

## Abutment Coefficients

$K_1$

Description	$K_1$
Vertical-wall abutment	1.00
Vertical-wall abutment with wing walls	0.82
Spill-through abutment	0.55

$K_2$

$K_2$  = Coefficient for angle of embankment to flow

$$K_2 = (\theta / 90)^{0.13}$$

$\theta < 90$  if embankment points downstream

$\theta > 90$  if embankment points upstream

I - Long Term Aggradation or Degradation

II - Contraction Scour

**III - Local Scour at Abutments - Froelich**

## Abutment Skew

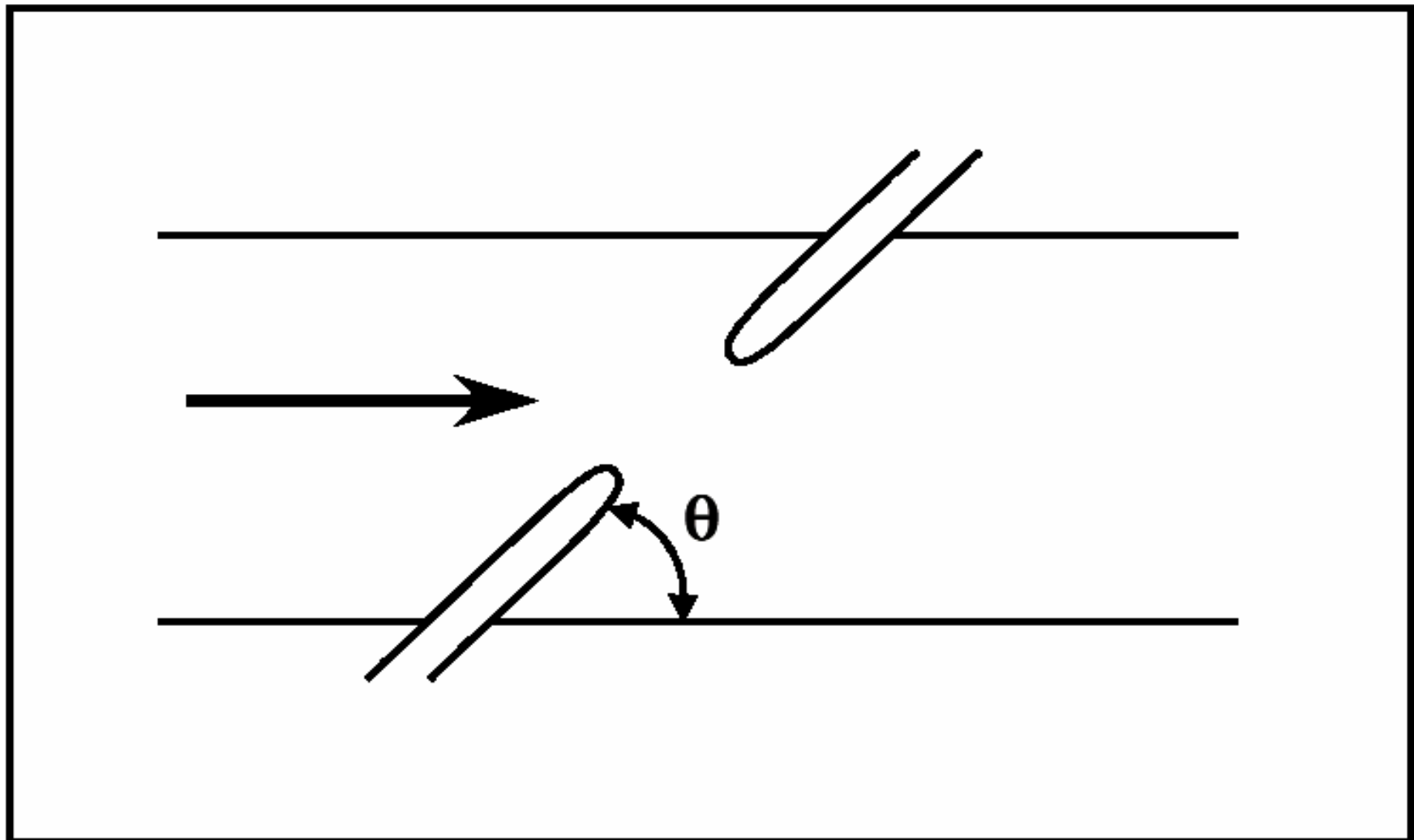

For abutments angles upstream, the depth of scour increases

I - Long Term Aggradation or Degradation

II - Contraction Scour (Clear-water)

**III - Local Scour at Abutments - HIRE**

## **II - HIRE (Richardson 1990) Live-bed Abutment Scour Equation**

(Recommended when the ratio of the length of the abutment (normal to flow) to flow depth > 25)

$$\frac{Y_s}{Y_1} = 4 \left[ \frac{K_1}{0.55} \right] K_2 Fr^{10.33}$$

$K_1$  = Coefficient for abutment shape

$K_2$  = Coefficient for angle of embankment to flow as calculated for Froelich's equation

$Fr$  = Froude Number based upon the velocity and depth adjacent to and upstream of the abutment

$Y_1$  = Depth of flow at the abutment on the overbank or in the main channel.

$Y_s$  = Scour depth

I - Long Term Aggradation or Degradation

II - Contraction Scour

III - Local Scour (at Abutments)

## Suggested design approach

- No reliable equations are available to predict all hydraulic flow conditions that may be reasonably expected to occur. Engineering judgement is required.
- Place piers & abutment on scour resistant foundation such as rock or deep foundation.
- Pilings should be driven below the elevation of long-term degradation and contraction scour.
- Need to consider the potential for lateral channel instability.
- Spread footings should be placed below the elevation of total scour.

# General Design Procedure

1. Select flood event
2. Develop water surface profiles
3. Estimate total scour
4. Plot total scour depth
5. Evaluate answers to above
6. Evaluate the bridge type, size and location
7. Perform bridge foundation analysis
8. Repeat the above procedure and calculate the scour for a super flood (500-year recommended). If hydrology for this flood is unavailable, use  $1.7 \times Q_{100}$ .

# **HECRAS EXAMPLE**



## Interim Procedure for Estimating Pier Scour with Debris

### D.1 ASSUMPTIONS

1. Debris aligns with the flow direction and attaches to the upstream nose of a pier. The width of the accumulation,  $W$ , on each side of the pier is normal to the flow direction.
2. The trailing end of a long slender pier does not add significantly to pier scour for that portion of the length beyond 12 pier widths. This is consistent with the current guideline in HEC-18 to cut  $K_2$  at  $L/a = 12$ .
3. The effect of the debris in increasing scour depths is taken into account by adding a width,  $W$ , to the sides and front of the pier. Engineering judgment and experience is used to determine the width,  $W$ .

### D.2 SUGGESTED PROCEDURE

1. Use  $K_1$  and  $K_2 = 1.0$
2. Project the debris pile and up to twelve pier widths of the pier length normal to the flow direction as follows:

$L' = L$  or  $12(a)$  (whichever is less)

$a_{proj} = 2W + a \cos\theta$  or  $W + a \cos\theta + L' \sin\theta$  (whichever is greater)

3. Use  $K_1$ ,  $K_2$ ,  $K_3$ ,  $K_4$ , and  $a_{proj}$  in the HEC-18 pier scour equation as follows:

$$\frac{y_s}{y_1} = 2.0(1.0)(1.0)K_3K_4\left(\frac{a_{proj}}{y_1}\right)^{0.65}Fr_1^{0.43}$$

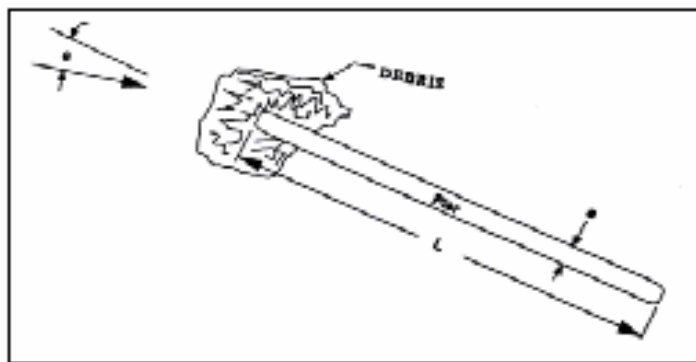

Figure D.1. Schematic for debris procedure.

## 6.8 TOPWIDTH OF SCOUR HOLES

The topwidth of a scour hole in cohesionless bed material from one side of a pier or footing can be estimated from the following equation:<sup>(68)</sup>

$$W = y_s (K + \text{Cot } \theta) \quad (6.22)$$

where:

$W$	=	Topwidth of the scour hole from each side of the pier or footing, m
$y_s$	=	Scour depth, m (ft)
$K$	=	Bottom width of the scour hole related to the of scour depth
$\theta$	=	Angle of repose of the bed material ranging from about $30^\circ$ to $44^\circ$

The angle of response of cohesiveness material in air ranges from about  $30^\circ$  to  $44^\circ$ . Therefore, if the bottom width of the scour hole is equal to the depth of scour  $y_s$  ( $K = 1$ ), the topwidth in cohesionless sand would vary from 2.07 to 2.80  $y_s$ . At the other extreme, if  $K = 0$ , the topwidth would vary from 1.07 to 1.8  $y_s$ . Thus, the topwidth could range from 1.0 to 2.8  $y_s$  and depends on the bottom width of the scour hole and composition of the bed material. In general, the deeper the scour hole, the smaller the bottom width. In water, the angle of repose of cohesionless material is less than the values given for air; therefore, a topwidth of 2.0  $y_s$  is suggested for practical applications (Figure 6.15).

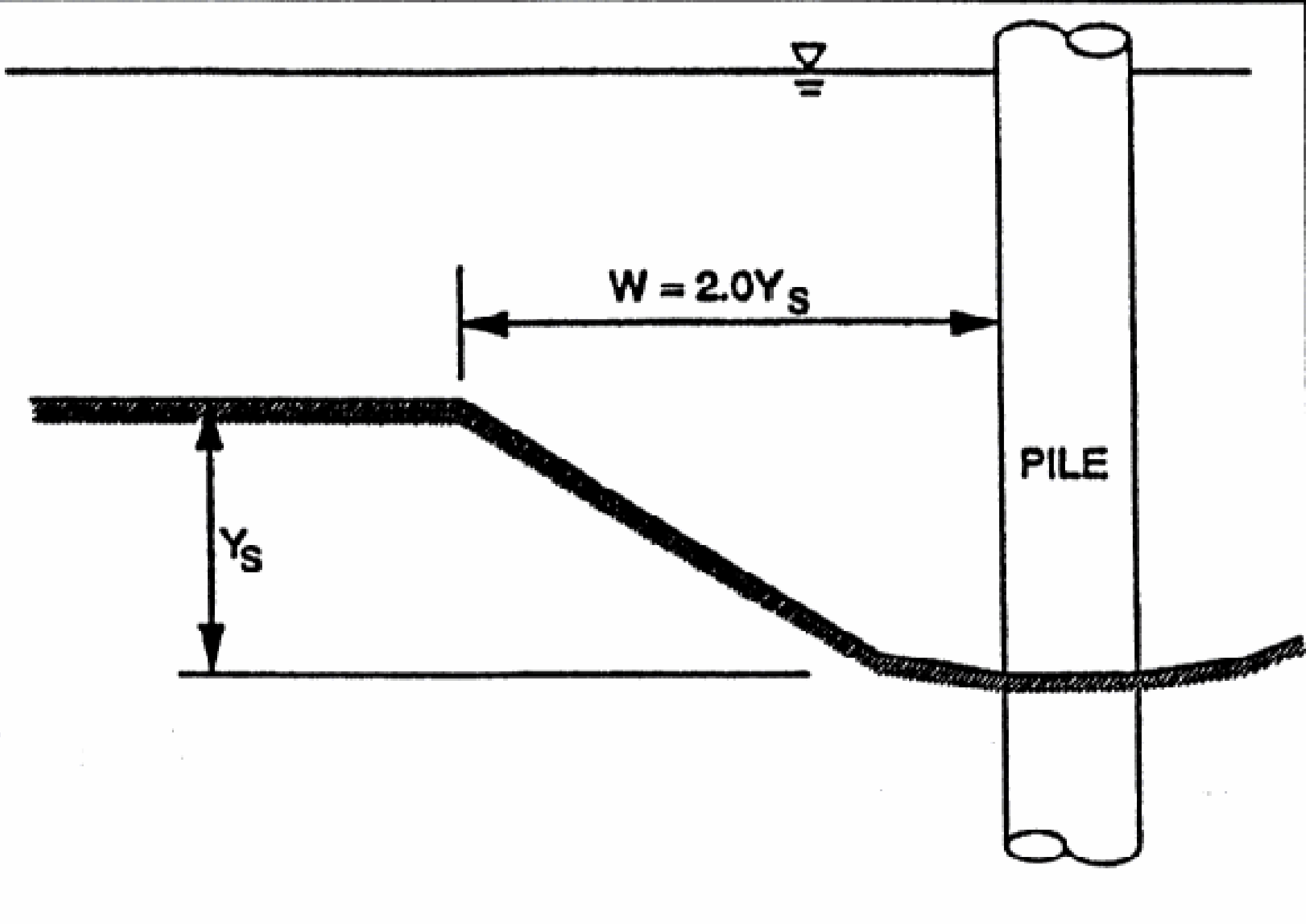

Mohammad Salim and Sterling Jones published "Scour Around Exposed Pile Foundations" in 1996 which more accurately estimates this case. However, more studies are needed for verification.

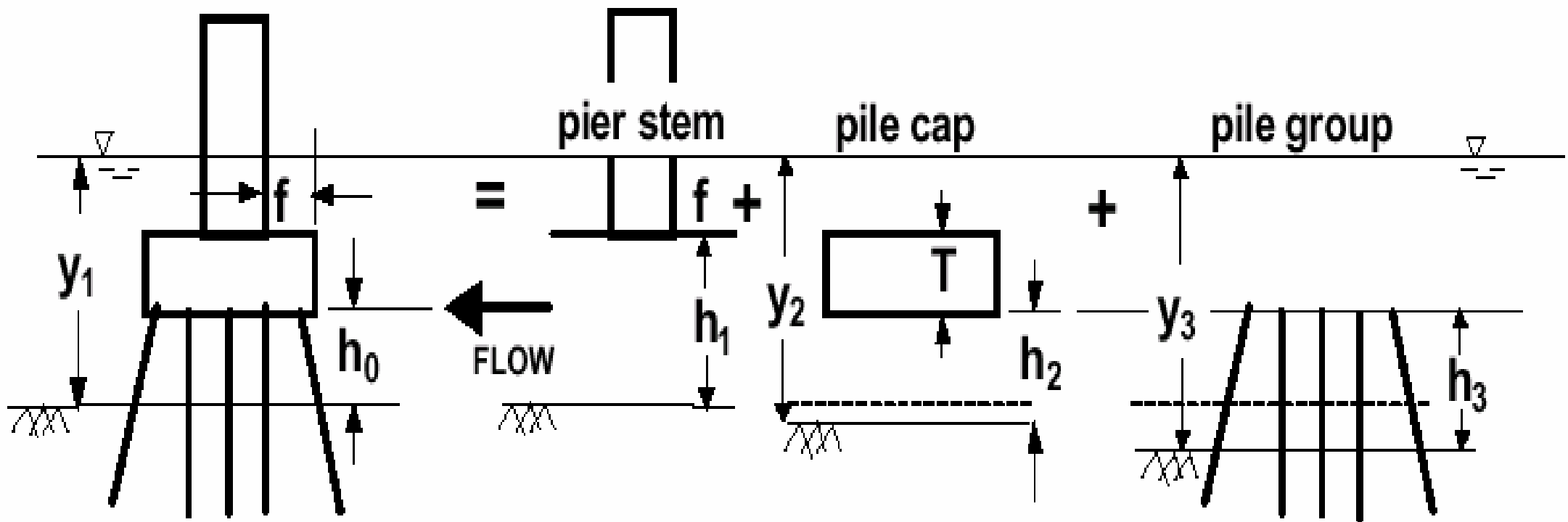

$$y_s = y_{s \text{ pier}} + y_{s \text{ pc}} + y_{s \text{ pg}}$$

Figure 6.4. Definition sketch for scour components for a complex pier.<sup>(59)</sup>

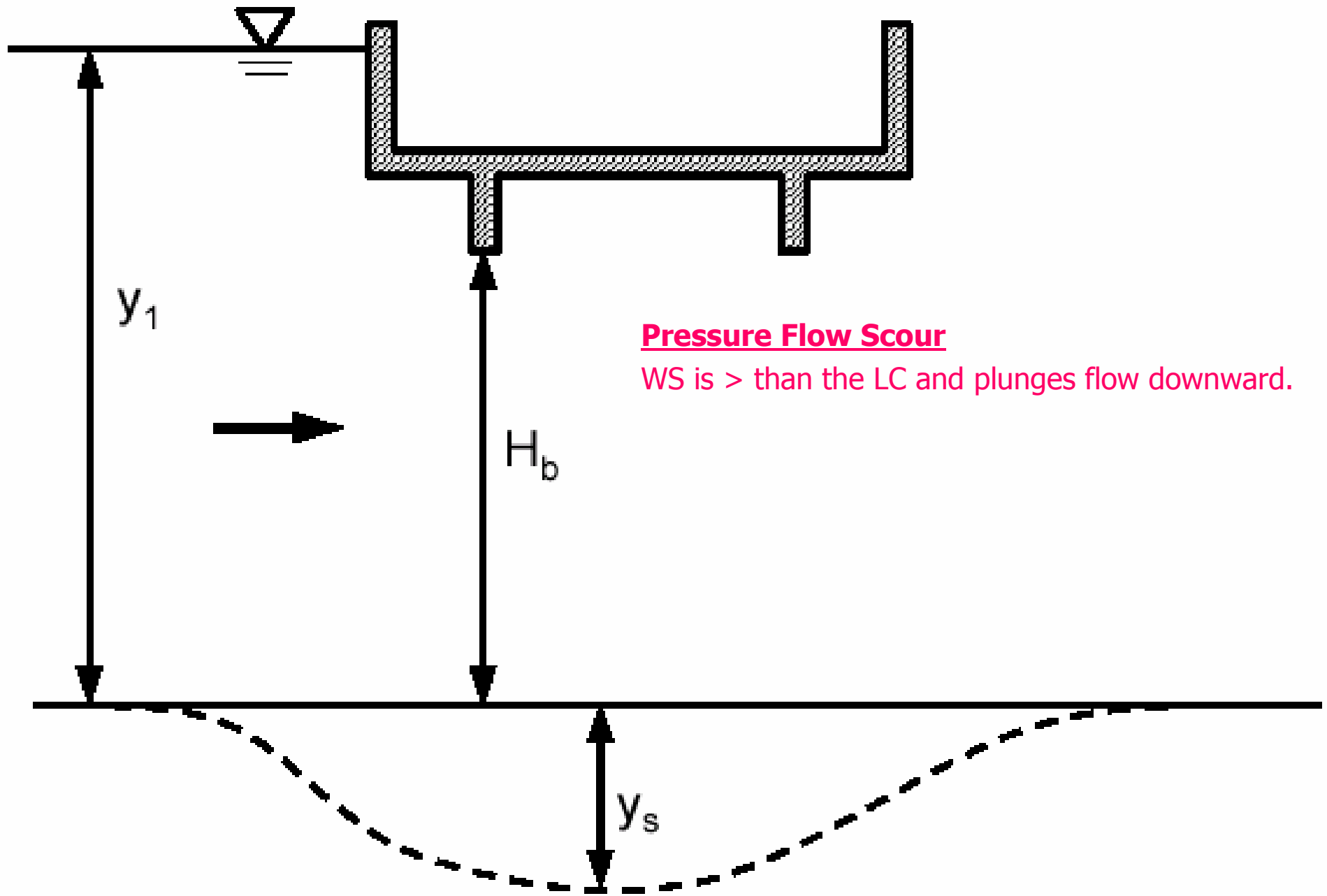

**Pressure Flow Scour**

WS is > than the LC and plunges flow downward.